

08 - 2024



# THE SPECK

The Construction Specifications Institute

The Knoxville Chapter meets on the second Tuesday of each month, except July & December. Guests are Welcome!  
ORGANIZED SEPTEMBER 1958 - CHARTERED MAY 1959



**THE SPECK** Editor

Stacy Flick Colbaugh - Editor  
[stcolbaugh@gmail.com](mailto:stcolbaugh@gmail.com)

THE SPECK is published monthly by the Knoxville Chapter of the Construction Specifications Institute. Readers are encouraged to submit articles and images of the construction industry interest for our membership. All submittals should be sent via e-mail in a typical file format, such as .pdf, .docx, or .jpg. Please verify the accuracy of the information such as correct dates, spelling, and grammar. Deadlines are the 25th of each month.

**CSI KNOXVILLE IS A MEMBER OF THE CSI GULF STATES REGION**

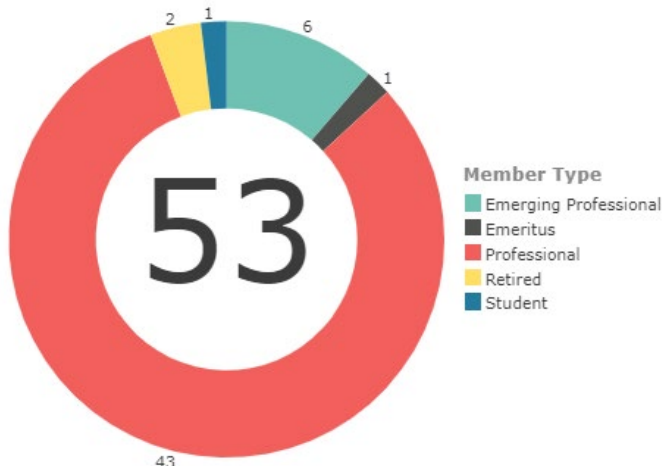

**CALENDAR OF EVENTS**

**AUGUST 2024**

- 06** **CSI Board Meeting** - Tuesday, August 6th  
 Meeting from 12:00 pm - 1:00 pm (EST)  
 Join Zoom Meeting:  
<https://us02web.zoom.us/j/83014858499>  
 Meeting ID: 830 1485 8499
  
- 13** **2024 Awards Banquet & Installation of New Officers**: Tuesday, August 13th at the Foundry on the Fair Site  
 6:00 pm-7:00 pm Social Gathering  
 7:00 pm Dinner  
 7:30 pm Awards Program  
 Free to each CSI member and 1 guest  
 Reservations required  
[Click here to RSVP for CSI Awards Gala](#)  
  
 Address: [747 Worlds Fair Park Dr., Knoxville, TN 37902](#)  
  
 This will be a special evening event, at 6:00 pm. There will be no lunch meeting at noon this month.
  
- 29** **Decompression Hour**: - Thursday, August 29th  
 Informal gathering, 5:30 pm at **Aubrey's Papermill** [6005 Brookvale Ln, Knoxville, TN 37919](#)

**SEPTEMBER 2024**

- 03** **CSI Board Meeting** - Tuesday, September 3rd  
 Meeting from 12:00 pm - 1:00 pm (EST)  
 Zoom Meeting
  
- 10** **CSI Chapter Meeting** - Tuesday, September 10th  
**Time: 11:30 AM EST - 1:00 PM (EST)**  
**"Adding Resiliency on the Roof: Vegetated Roofs and Blue Roofs"** Presented by Chris Sharp, Styro Systems, 1 AIA LU/HSW  
  
**AGC Address:**  
[3306 Ragsdale Ave NW, Knoxville, TN 37909](#)

**OCTOBER 2024**

- 01** **CSI Board Meeting** - Tuesday, October 1st  
 Meeting from 12:00 pm - 1:00 pm (EST)  
 Zoom Meeting
  
- 08** **CSI Chapter Meeting** - Tuesday, October 8th  
**Time: 11:30 AM EST - 1:00 PM (EST)**  
**"2024 IBC Significant Changes - COK Transition from 2018 Code Family to 2024 Codes"**  
 Presented by James Tente, City of Knoxville, 1 AIA LU/HSW  
  
**AGC Address:**  
[3306 Ragsdale Ave NW, Knoxville, TN 37909](#)

PLEASE DOWNLOAD AND IMPORT THE FOLLOWING ICALENDAR (.ICS) FILES TO YOUR CALENDAR SYSTEM. [MONTHLY ZOOM MEETING](#)

# THE PRESIDENT'S MESSAGE

## WHAT A SHORT, STRANGE TRIP IT'S BEEN...

CSI Knoxville Chapter Planning Retreat was a success! We have so many new ideas and exciting events planned for the upcoming year! CSI Knoxville Chapter is rolling out the red carpet for our CSI Leaders! The CSI Awards Gala and Officer Installation is on Tuesday, August 13th at 6:00 pm. It is free to CSI Members and one guest... it will be at The Foundry on the Fair Site. RSVP today! [Click here to RSVP for CSI Awards Gala](#)



Knoxville Chapter has lots of opportunities for folks to plug in and get involved, so reach out to me if you could spare a little volunteer time to help make our mutual chapter experience even stronger.

Let's do this! Onward and Upward!

Brent Williams  
 Chief Fusion Evangelist,  
 Archteva, LLC  
 Inline image  
 10629 Hardin Valley Rd, #215  
 Knoxville, TN 32932  
 Direct 865.924-9757



# HINDSIGHT

## CSI KNOXVILLE PLANNING RETREAT, SATURDAY, JULY 13TH

Photos By: Ms. Susan Davis, CSI,CDT  
[susanscottdavis@gmail.com](mailto:susanscottdavis@gmail.com)

Thank you to everyone who joined us on Saturday to plan for the upcoming year!  
 If you're thinking about joining CSI, now is the perfect time! We have tons of great programs and events coming up this year.







**CSI LEARNING**

**WHAT I LEARNED FROM CSI... PSYCHO SLASHER OR LEGIONELLA BACTERIA, WHICH WAY DO YOU WANT TO “BREATHE YOUR LAST BREATH” IN THE SHOWER?**

**Gary T. Bergeron FCSI**  
 Principal and Co-Owner  
 Kelso-Regen Associates, Inc.  
 Consulting Engineers  
 CSI Gulf States Region  
 Treasurer & Technical chair  
 ACE mentorship Greater  
 Knoxville fundraising chair  
 O: 865-588-5348  
 C: 865-748-6304  
[gary@kelso-regen.com](mailto:gary@kelso-regen.com)



Legionella can live and grow in biofilm

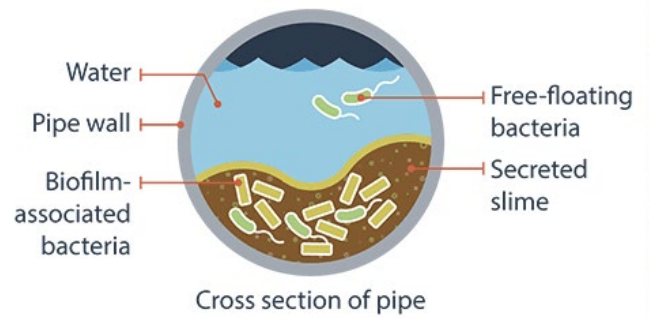

LEGIONELLA

[https://www.cdc.gov/control-legionella/php/public-health-strategy/?CDC\\_AAREF\\_VAL=https://www.cdc.gov/legionella/wmp/overview/growth-and-spread.html](https://www.cdc.gov/control-legionella/php/public-health-strategy/?CDC_AAREF_VAL=https://www.cdc.gov/legionella/wmp/overview/growth-and-spread.html)

in 1976 at a Philadelphia convention of the American Legion. 211 of the convention attendees became ill and 29 died. The illness was finally traced back to a poorly maintained HVAC cooling tower. This contaminated cooling tower water mist was inhaled by the convention attendees.

Legionnaires bacteria can also propagate in a domestic hot water system. A person taking a hot steamy bath or shower can inhale the steam. This is not usually a problem unless residents are immune compromised such as in senior living housing or hospitals. The easiest way to kill the bacteria is to maintain a minimum 140° F water temperature. The 2015 International Plumbing Code (IPC) required the water heater tank to be maintained at 140 with temperature limiting device mounted at the water heater. The next iteration of the IPC is rumored to have a six-foot limitation on dead-end legs of



Many of us are familiar with the Psycho slasher type movies where someone gets attacked in a steam-filled shower. But there are other serious issues at work in steam-filled showers, such as the bacteria causing legionnaires disease. Legionnaires disease is evidenced by pneumonia-like symptoms that was first diagnosed



<https://www.abc.net.au/news/2020-06-21/psycho-hitchcock-film-broke-ground-got-around-hollywood-censors/12367844>

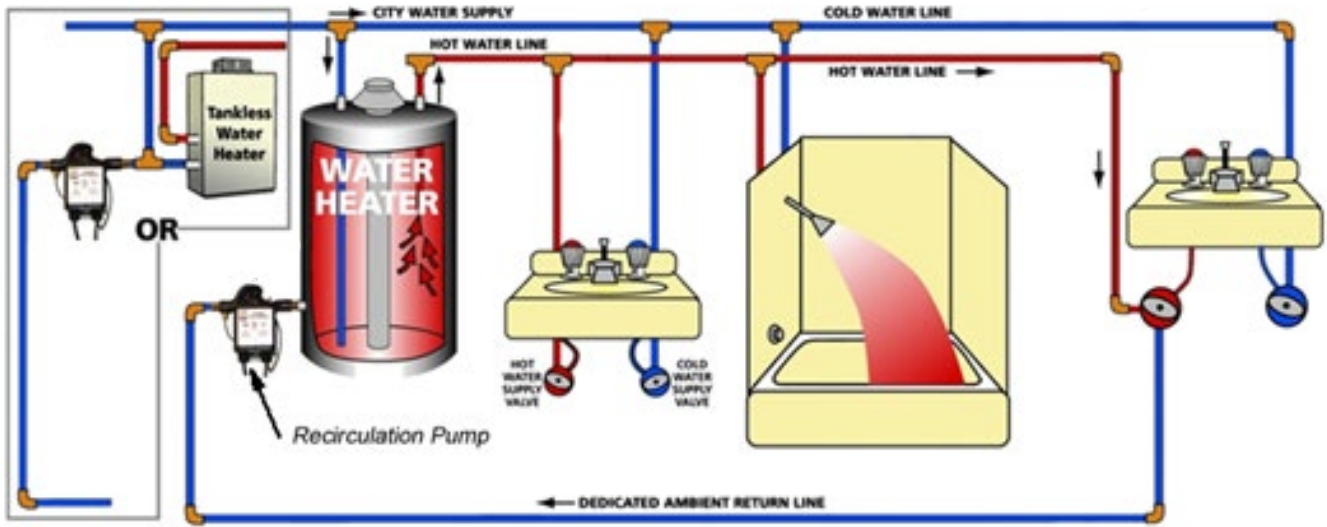

UNPROTECTED HOT WATER SYSTEM W/O MIXING VALVES  
<https://simonshvacny.com/water-heaters/>

stagnant water piping. The ASHRAE, ASPE and ASSE organizations have issued several piping diagrams which indicate how the hot water system should be designed to mitigate legionnaires bacteria growth. The water heater temperature is maintained at 140° F with a thermostatic mixing valve which reduces the water temperature to

120° F to distribute throughout the building with a hot water recirculating pump. Since 120° F could cause scalding, a terminal thermostatic mixing valve reducing the water temperature to 105° F is also specified at tub/showers and underneath any hand washing lavatory or similar plumbing fixture that could cause scalding.

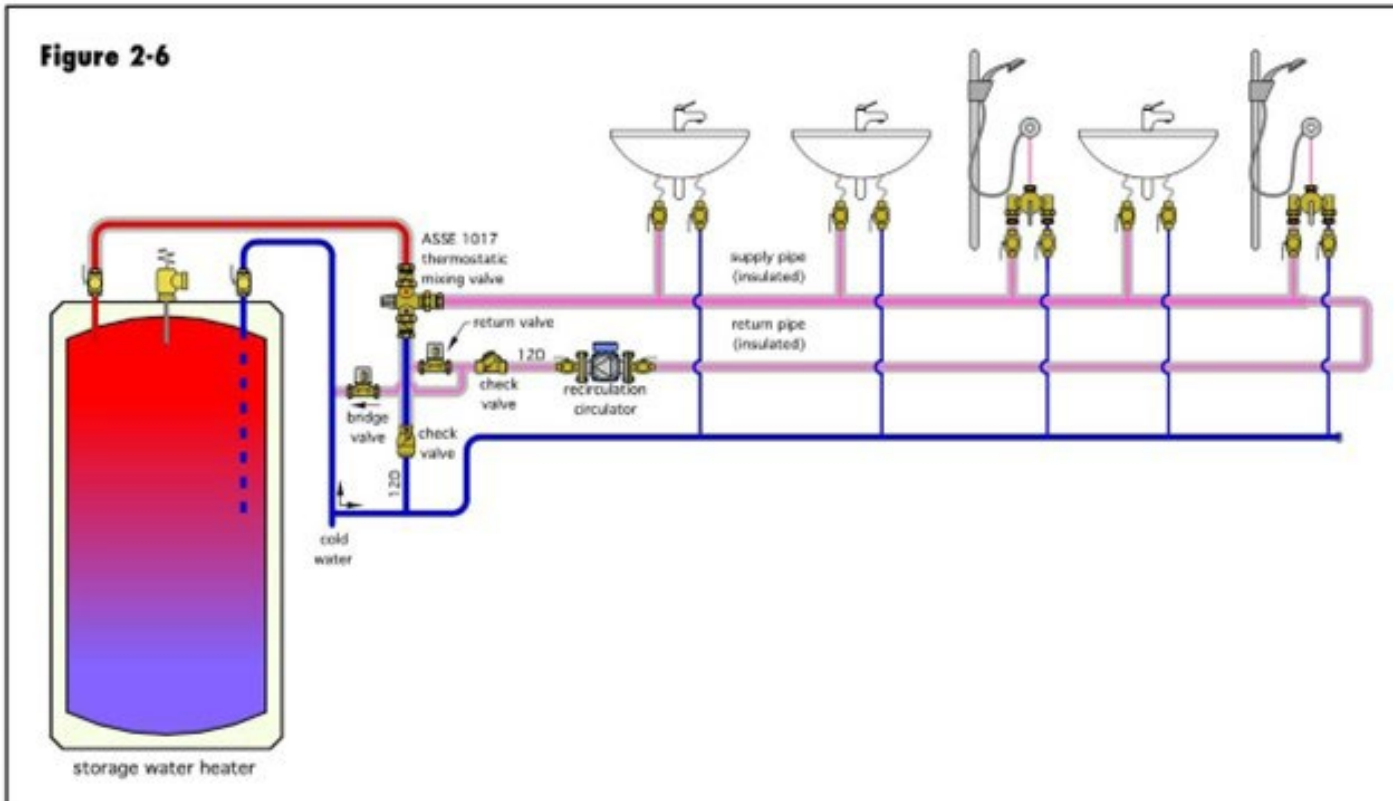

PROTECTED HOT WATER SYSTEM WITH MIXING VALVES  
<https://forum.heatinghelp.com/discussion/166397/is-this-diagram-correct-lochinvar-instantaneous-wh-with-mixing-valve-and-recirculation-pump>  
 PROTECTED HOT WATER SYSTEM WITH MIXING VALVES



Several standards for the thermostatic mixing valves have been developed by the plumbing industry. The mixing valve at the water heater should meet the “Guidelines for Temperature Control Devices” by the American Society Sanitary Engineering ASSE 1017 while the mixing valve at the lavatory should meet ASSE 1070 and the shower valve should meet ASSE 1016. The facility manager at the senior living facility or hospital is responsible for regular testing for bacteria at random points of use. If the water heater and mixing valves are maintained, no issues should arise. If you want to learn more about issues like these in the construction and design industry, please come to the next local or regional CSI meeting. For more information contact Gary Bergeron via email at [Gary@Kelso-Regen.com](mailto:Gary@Kelso-Regen.com)

POINT OF USE MIXING VALVE UNDER LAVATORY

[HTTPS://WWW.CASHACME.COM/CA/EN/THERMOSTATIC-MIXING-VALVES](https://www.cashacme.com/ca/en/thermostatic-mixing-valves)



MASTER MIXING VALVE AT WATER HEATER

[HTTPS://WWW.PMMAG.COM/ARTICLES/104015-THE-CASE-FOR-THE-MASTER-MIXING-VALVE](https://www.pmmag.com/articles/104015-the-case-for-the-master-mixing-valve)



## CSI NEWS

## SUZAN JORDAN WINS GULF STATES REGION'S HIGHEST AWARD

Suzan Jordan, CSI, CDT, CCPR, was presented the Robert V. Bishop Award this week at the CSI Gulf States Region Conference in Jackson, MS. This is the Gulf States Region's highest honor.

Ms. Jordan is a Dupont Tyvek Senior Certified Building Envelope Consultant. She is an authority on the subject of moisture management and the building envelope. She often has classes at CSI meetings and with architects, building officials and building contractors educating the design and construction industry about best practices concerning the building envelope and moisture management. She has remarked that the networking opportunities and relationships fostered in CSI provide



Suzan Jordan, left; Kathy Proctor, right

avenues to reach more prospective clients and help her be seen as a trusted resource to designers and contractors.

She is a member of the Knoxville Chapter and has served in many roles in both our chapter and the Gulf States Region. She is a familiar face at all Gulf States planning meetings, Region conferences and Institute conventions.

The award is given to a Gulf States CSI member who has rendered extraordinary service to the Construction Specifications Institute and especially the members in the Gulf States which include Tennessee, Arkansas, Louisiana, Mississippi, Alabama and the panhandle of Florida. The CSI Gulf States Region Operating Guide states, "This award will be given to a member having at least ten (10) years of continuous membership and who has portrayed exceptional and meritorious service and devotion to the Gulf States Region and to the principles of The Construction Specifications Institute. This award shall be considered as the highest recognition that can be given by the Region."

Recipients of the Robert V. Bishop Award serve as the jury for nominees submitted for this honor. Their service continues to embody the dedication and lifelong service to the Gulf States Region displayed by Mr. Robert V. Bishop, FCSI, CCS. The Knoxville Chapter has one other Robert V. Bishop Award recipient, Kathy Proctor.



# PROJECT ARCHITECT

Join our dynamic and growing architectural firm, committed to delivering innovative and highly collaborative design solutions. Our projects are diverse, ranging from custom residential to restaurants, hotels, storage facilities and commercial shell buildings.

As a project architect with oysk3 architects you will play a key role in leading and managing multiple projects from conception, through design, navigate permitting and into construction at times. This position requires being fully licensed and five to eight years of project management experience with strong people and communication skills.

## Responsibilities

### Project Leadership

- o Oversee and guide the design process, for a majority of projects within the firm.
- o Communicate effectively within the firm, with various consultants and to all clients.
- o Ensure projects meet, or exceed, expectations set, including design needs, budget and schedule.

### Client Interactions

- o Collaborate with clients to understand and help define their vision, needs and project requirements.
- o Consistently communicate any questions, issues or schedule updates.
- o Respond in a timely manner to all inquiries.

### Team Management

- o Lead and mentor our growing team of interns and production staff.
- o Foster a team approach with a collaborative and creative mindset.
- o Encourage learning, asking questions and continued growth for all.

### Quality Assurance

- o Support processes in place to provide a consistent quality in project deliverables.
- o Conduct team and project reviews to maintain a consistent, reliable and responsive environment for staff, consultants and clients.
- o Be open to constructive criticism as well as share it in a supportive manner.

## Qualifications

- o Licensed Architect, held for eight to ten years.
- o Demonstrate experience in various commercial project completion in a portfolio.
- o Proven ability to lead and manage a project team.
- o Excellent interpersonal and communication skills., verbal and written.

CALL US 865-523-8200

EMAIL US [CONTACT@OYSK3ARCHITECT](mailto:CONTACT@OYSK3ARCHITECT)

VISIT US 1545 WESTERN AVE, KNOXVILLE, TN 37921

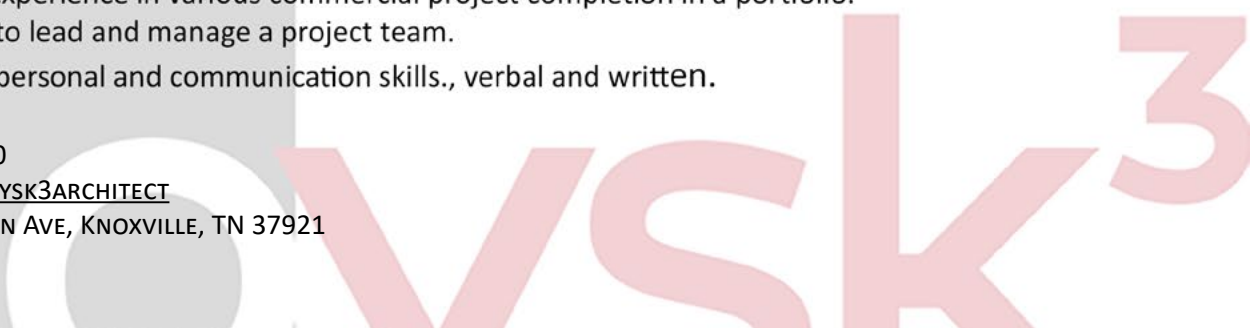

## CSI NEW MEMBER NEWS

### WELCOME NEW MEMBER! CHRIS LEIBENSPERGER, CSI

May I introduce one of our newest members, Chris Leibensperger. He is part of the architectural team at R2R Studio here in Knoxville, where he is currently pursuing his architectural license. The firm focuses on a variety of project types including commercial, residential, interior architecture, and brand development design.



Chris said that he has been able to work on several different projects in the East Tennessee area including the Shops at Bexhill, Southern Craft BQQ in Greeneville, Patriot's Chicken in Blaine, Monkee's Retail at the Orangery Village, Sweet P's BBQ in Fountain City, Tennessee Stud Cidery in Pigeon Forge and the Town Center Plaza in Gatlinburg. He said that his favorite part of the profession is the "wide range of design challenges each project presents, and the impact each project will have on people as the space is used."

Chris is from Western New York, between Buffalo and Rochester. He graduated from SUNY Alfred State

College in 2009. He came to Knoxville in April of 2021 and joined R2R Studio. When asked what drew him to study architecture, he said, "I grew up building with Lego's and always seemed to create buildings, towns, or houses. In high school I focused on construction and technology classes [where] my passion and interest in how a building came together really took off."

Chris said that he joined CSI to better understand the science of buildings, the different trades in the industry and to network and build relationships. Before moving to Tennessee, he had started getting involved in the local NY CSI chapter. Once here in Knoxville, he was invited to a chapter meeting by Gary Bergeron, FCSI. He hopes to continue to grow and learn, both personally and professionally.

Chris has a daughter who is 6, a son who is 4, and an 8-year-old black lab mix named Bailey. He enjoys hiking, golf, and an occasional nice glass of bourbon. Please reach out and introduce yourself to Chris and welcome him to CSI Knoxville.



# CSI KNOXVILLE NEWS

## CITY OF KNOXVILLE 2024 I-CODES UPDATES

The City of Knoxville Plans Review and Inspections Department hosted two public meetings highlighting significant changes to the 2024 I-Codes and 2023 NEC. The meetings were held at the City of Knoxville Public Works conference room. Topics for discussion were presentations on the significant updates for the 2024 I-Codes, MEP Updates, 2023 NEC, and TN Senate Bill No. 2100 Third Party Bill presentation and then followed up by some Q&A. Flyers were shared with links to the Google Slides presentations Slides, see below. If your organization would like to have a presentation or discussion at an upcoming monthly or quarterly meeting, please contact Timothy Marcum and he will help to accommodate as many groups as possible.

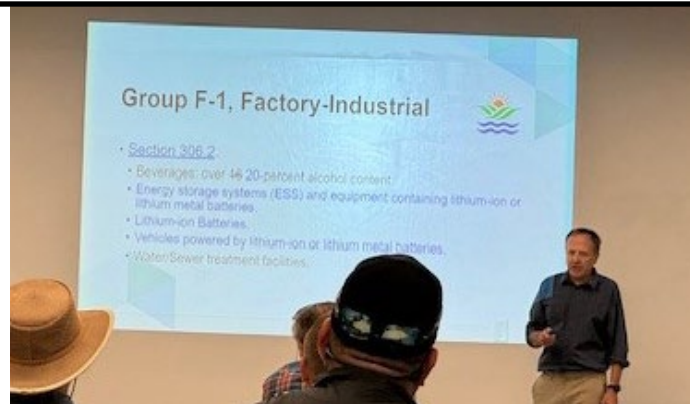

Jim Tente (JMT), Building & Plans Review Division Chief  
[jtente@knoxvilletn.gov](mailto:jtente@knoxvilletn.gov)  
 865-755-2579



Timothy Marcum (TAM), Deputy Director - Building & Trades  
[tmarcum@knoxvilletn.gov](mailto:tmarcum@knoxvilletn.gov) 865-755-2548

Not pictured: Clay Taylor (CAT), MEP Chief  
[ctaylor@knoxvilletn.gov](mailto:ctaylor@knoxvilletn.gov) 865-755-2542

[Click Here for Presentation Link: 2018-2024 Significant Building Updates IEBC, IBC, A117.1, IRC](#)



# CSI GULF STATES REGION LEADERS – 2023-2024

## OFFICERS

President Randall Lewis, CSI, AIA  
J H & H Architects, PA  
1047 N Flowood Dr  
Flowood, MS 39232-9533  
[rlewis@jhharchitects.com](mailto:rlewis@jhharchitects.com)  
601-948-4601

Vice President Michael Zielinski, CSI,  
CCCA  
LRK Architects  
2100 Dalkeith Drive  
Germantown, TN 38139  
[maz.ecc@comcast.net](mailto:maz.ecc@comcast.net)  
901-652-5612

Treasurer Mr. Gary Bergeron, BS, FCSI,  
ASHRAE, ASPE  
201 Sherlake Ln Ste 101  
Knoxville, TN 37922-2376  
[gary@kelso-regen.com](mailto:gary@kelso-regen.com)  
865-588-5348

Secretary Mr. Jeffrey Parnell, CSI, CDT,  
AIA  
FourFront Design  
5101 Wheelis Ave, Suite 215  
Memphis, TN 38117  
[jeffrey@4f.design](mailto:jeffrey@4f.design)  
901-767-3924

Immediate Past President Jerry Curtis, RA,  
CSI, Member Emeritus, NCARB  
204 Green Valley Blvd.  
Franklin, TN 37064  
[tnbass@comcast.net](mailto:tnbass@comcast.net)  
615-969-8970

Region Director Betina Latiker, CSI, CDT  
5883 Wiggins Loop Rd  
Carthage, MS 39051  
[blatiker@hotmail.com](mailto:blatiker@hotmail.com)  
601-209-4671

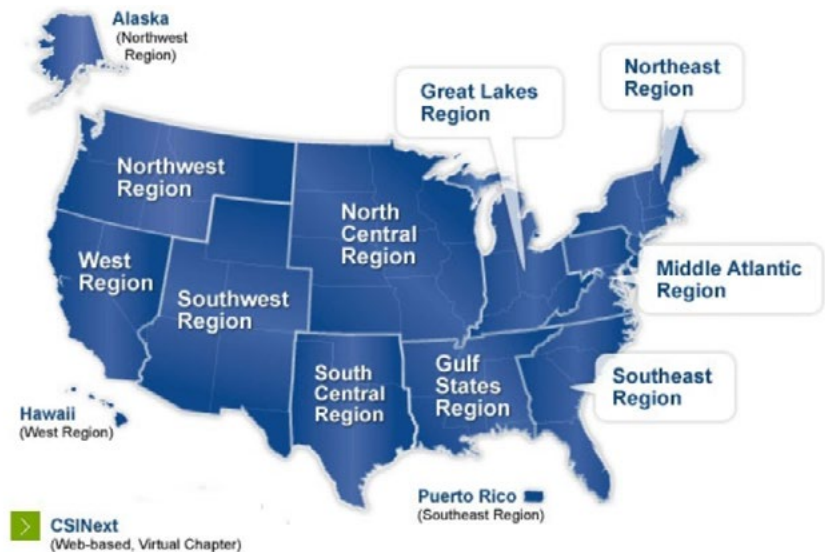

# CSI KNOXVILLE MEMBERS – AUGUST 2024

Abigail Allshouse, RA, CSI, CDT  
 Alexandria Anderson, CSI-EP, CDT  
 Mrs. Michelle Barillaro, CSI  
 Mr. Gary Bergeron, BS, FCSI, ASHRAE, ASPE  
 Mr. Benjamin Brewer, BA, CSI, CCCA, CDT, AIA, NCARB  
 Ms. Deborah Brooks, CSI  
 Josh Buchanan, CSI  
 Mr. Geoffrey Cavalier, CSI, AIA  
 Ms. Stacy Colbaugh, CSI, CDT, AIA  
 Michaelanne Collins, CSI  
 Ms. Patricia Corbitt, CSI  
 Ms. Donna Covert, CSI  
 Mr. Paul Crow, CSI  
 Ms. Susan Davis, CSI, CDT  
 William Dunklin, RA, CSI, NCARB  
 Shannon Elliott, CSI, AIA, NCARB  
 Mr. Joseph Fielden, CSI  
 Kathryn Fuller, CSI, CDT, AIA, NCARB  
 Peter Giddings, CSI  
 Katie Goethert, CSI  
 Ms. Alisha Gotham, CSI-EP  
 Mr. Tyler Goza, CSI, AIA  
 Mr. A. Gordon Heins III III, CSI  
 Kelley Hicks, MA, CSI, AIA

Suzan Jordan, CSI, CCPR, CDT  
 Karina Kane, CSI-S  
 Whitney Kaul, CSI, LEED GA  
 Allison Kelly, CSI  
 Chris Leibensperger, CSI  
 Mr. Douglass Lowrie, CSI  
 Danielle Mathews Hemsley, CSI-EP  
 Mr. R. Aaron Miller, BA, CSI, AIA  
 Michelle Mokry, BA, CSI, AIA, LEED AP  
 Brien Montecinos, CSI  
 James Odle, CSI  
 Dipakkumar Patel, CSI  
 Mr. Paul Pierson, CSI, Member Emeritus, AIA  
 Mrs. Katherine Proctor, RA, FCSI, CDT  
 Mr. Curtis Rolen, CSI  
 Mr. James Rose, CSI  
 Briley Saiyasak, CSI-EP, Assoc. AIA  
 Andy Salley, CSI, CDT, RCDD  
 Mr. Samer Shatara, CSI  
 Mr. Jeremy Shipp, RA, CSI, LEED AP  
 Mr. Brian Sickles, CSI, CDT, AIA  
 Mr. Jerry Smith, CSI  
 Maureen Sotak, CSI-EP  
 Mr. Peter Tarbell, CSI  
 Mr. William Trimble Jr., CSI  
 Taniya Vinod, CSI-EP  
 Thomas Wade, CSI  
 Chuck Whited, CSI  
 Mr. Williams Whitt, CSI



PO Box 81  
Annapolis Junction, MD 20701  
Phone: 800-689-2900  
CSI Tax ID#: 53-0242938  
Fax to: 703-940-8600

### MEMBERSHIP ENROLLMENT FORM

**Personal Information**  Mr.  Ms.  Mrs.  Dr.

First name: \_\_\_\_\_ Middle initial: \_\_\_\_\_ Last name: \_\_\_\_\_

Nick name: \_\_\_\_\_

Title: \_\_\_\_\_

Firm name: \_\_\_\_\_

Website: \_\_\_\_\_

Mailing Address: \_\_\_\_\_

City | State | Zip: \_\_\_\_\_

Business phone: \_\_\_\_\_ Fax: \_\_\_\_\_

( ) ( ) ( )

Email: \_\_\_\_\_

Date of birth: \_\_\_\_\_

Please review the listings on the back and enter the corresponding number(s) that best describe the following:

Occupation code: \_\_\_\_\_ Firm type code: \_\_\_\_\_

---

**Membership Dues and Chapter Designation**

Membership Dues (See types of membership above) ..... \$ \_\_\_\_\_

Home Chapter (See reverse side) ..... Included

Membership Certificate (Optional) ..... \$ 15.00

**Total (US funds only)** ..... \$ \_\_\_\_\_

Signature\* \_\_\_\_\_

\*Required to validate your enrollment form (Payable to CSI-please specify "Member Dues" and if renewing membership include member ID on memo line.)

Visa  Mastercard  AMEX  Check

Card # \_\_\_\_\_ CVV Code \_\_\_\_\_ Exp Date \_\_\_\_\_

Signature\* \_\_\_\_\_

\*Signature required for credit card authorization

Enroll online at [www.csiresources.org/join](http://www.csiresources.org/join)

**MEMBERSHIP TYPES**

- Professional: \$375**  
I am a technically experienced individual whose primary function is to author, manage, or communicate building information; to create, interpret, or use construction documents; or to educate, support, or assist the construction industry.
- Emerging Professional: \$200\***  
I am an individual who has less than three years experience in any construction-related field and am a prospective Professional Member.
- Student: \$70\***  
I am a full-time student enrolled in an undergraduate or graduate program in a construction industry curriculum at an educational institution.

\*Emerging Professional membership is limited to three years, at which time members must renew at the Professional level.

---

**CSI Membership**

CSI Membership is good for one year, with your membership starting the day that your payment is received and processed.



This Enrollment Form pricing is valid from July 1, 2022 through July 30, 2023. Prices and information are subject to change.



Membership has its benefits  
 Your CSI member benefits include generous discounts on CSI standards and formats such as MasterFormat® Groups Subgroups And Divisions, as well as discounts on numerous resources to assist you in the preparation of specifications, as well as other construction documents.

Not a CSI Member? Join Today!  
[www.csiknoxville.org](http://www.csiknoxville.org)



## 2023-2024 CSI KNOXVILLE CHAPTER LEADERS

### OFFICERS

President	Brent Williams	<a href="mailto:brent@archteva.com">brent@archteva.com</a>	(865) 924-9757
Secretary	Geoffrey Cavalier	<a href="mailto:cavaliergeoffrey@gmail.com">cavaliergeoffrey@gmail.com</a>	(615) 964-1260
Treasurer	Suzan Jordan	<a href="mailto:suzanwjordan@icloud.com">suzanwjordan@icloud.com</a>	(865) 389-9476
Past President	Kathryn Fuller	<a href="mailto:kathrynf@mbicompanies.com">kathrynf@mbicompanies.com</a>	(865) 584-0999
Lord of the Privy Council	Gary Bergeron	<a href="mailto:gary@kelso-regen.com">gary@kelso-regen.com</a>	(865) 748-6304

### DIRECTORS

#### 2022-2024

Michelle Barillaro	<a href="mailto:mbarillaro@rouseconstruction.com">mbarillaro@rouseconstruction.com</a>	(865) 777-9776
Patrick Brown	<a href="mailto:pbrown@rossfowler.com">pbrown@rossfowler.com</a>	(865) 637-1100
Tyler Goza	<a href="mailto:tgoza@dia-arch.com">tgoza@dia-arch.com</a>	(865) 410-7431

#### 2024-2026

Ginger Azpurua	<a href="mailto:ginger.azpurua@gmail.com">ginger.azpurua@gmail.com</a>	(865) 409-2821
Katie Goethert	<a href="mailto:katie@oysk3architects.com">katie@oysk3architects.com</a>	(865) 523-8200
Lauretta Cocke	<a href="mailto:lcocke@knoxvilletn.gov">lcocke@knoxvilletn.gov</a>	(865) 755-2540

### COMMITTEES

#### Member Services

Membership	Samer Shatara	<a href="mailto:sshatara@denark.com">sshatara@denark.com</a>	(865) 388-3661
House	Stacy Colbaugh	<a href="mailto:sfcolbaugh@gmail.com">sfcolbaugh@gmail.com</a>	(865) 599-3956
	Ginger Azpurua	<a href="mailto:ginger.azpurua@gmail.com">ginger.azpurua@gmail.com</a>	(865) 409-2821
	Peter Giddings	<a href="mailto:peterzgiddings@gmail.com">peterzgiddings@gmail.com</a>	

#### Education

Education / Programs	Tyler Goza	<a href="mailto:tgoza@dia-arch.com">tgoza@dia-arch.com</a>	(865) 410-7431
----------------------	------------	--	----------------

#### Student Chapter

President	Collin Rummage	<a href="mailto:crummag1@vols.utk.edu">crummag1@vols.utk.edu</a>
-----------	----------------	--

#### Recognition

Technical	Gary Bergeron	<a href="mailto:gary@kelso-regen.com">gary@kelso-regen.com</a>	(865) 748-6304
Certification	Stacy Colbaugh	<a href="mailto:sfcolbaugh@gmail.com">sfcolbaugh@gmail.com</a>	(865) 599-3956
	Brian Sickles	<a href="mailto:brian.sickles@ssainc.com">brian.sickles@ssainc.com</a>	(865) 867-7582
Awards	Vacant		

#### Communication

Publication/ Website	Stacy Colbaugh	<a href="mailto:sfcolbaugh@gmail.com">sfcolbaugh@gmail.com</a>	(865) 599-3956
Faculty Advisor	Kevin Stevens	<a href="mailto:kevin.stevens@utk.edu">kevin.stevens@utk.edu</a>	(865) 805-6466
Academic Affairs	Brian Sickles	<a href="mailto:brian.sickles@ssainc.com">brian.sickles@ssainc.com</a>	(865) 867-7582

#### Fundraising

Product Show	Josh Brock	<a href="mailto:joshua.brock@generalshale.com">joshua.brock@generalshale.com</a>	(865) 388-1833
Golf Tournament	Wes Crow	<a href="mailto:wcrow@johnsongalyon.com">wcrow@johnsongalyon.com</a>	(865) 770-0727

#### Chapter Administration

Planning / Historian	Kathy Proctor	<a href="mailto:ksp53@me.com">ksp53@me.com</a>	(865) 599-7783
Bylaws & Op Guide	Geoffrey Cavalier	<a href="mailto:cavaliergeoffrey@gmail.com">cavaliergeoffrey@gmail.com</a>	(615) 964-1260